

MIN2_25

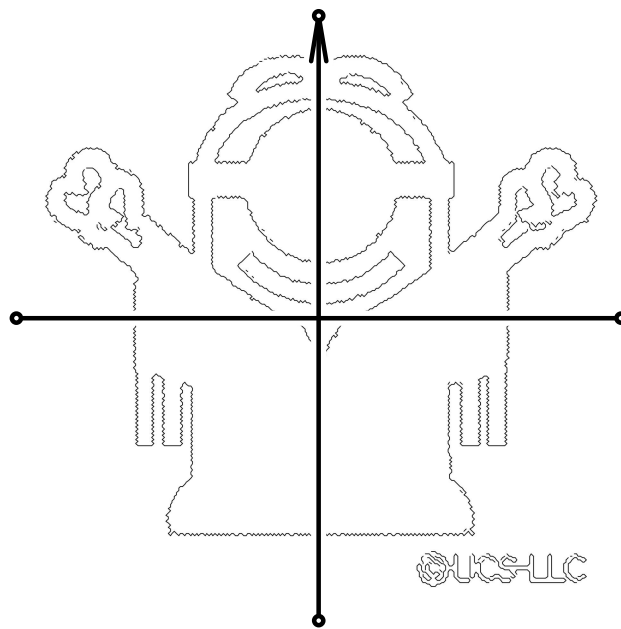

Design Size (w, h): 72.2 x 69.8 mm